

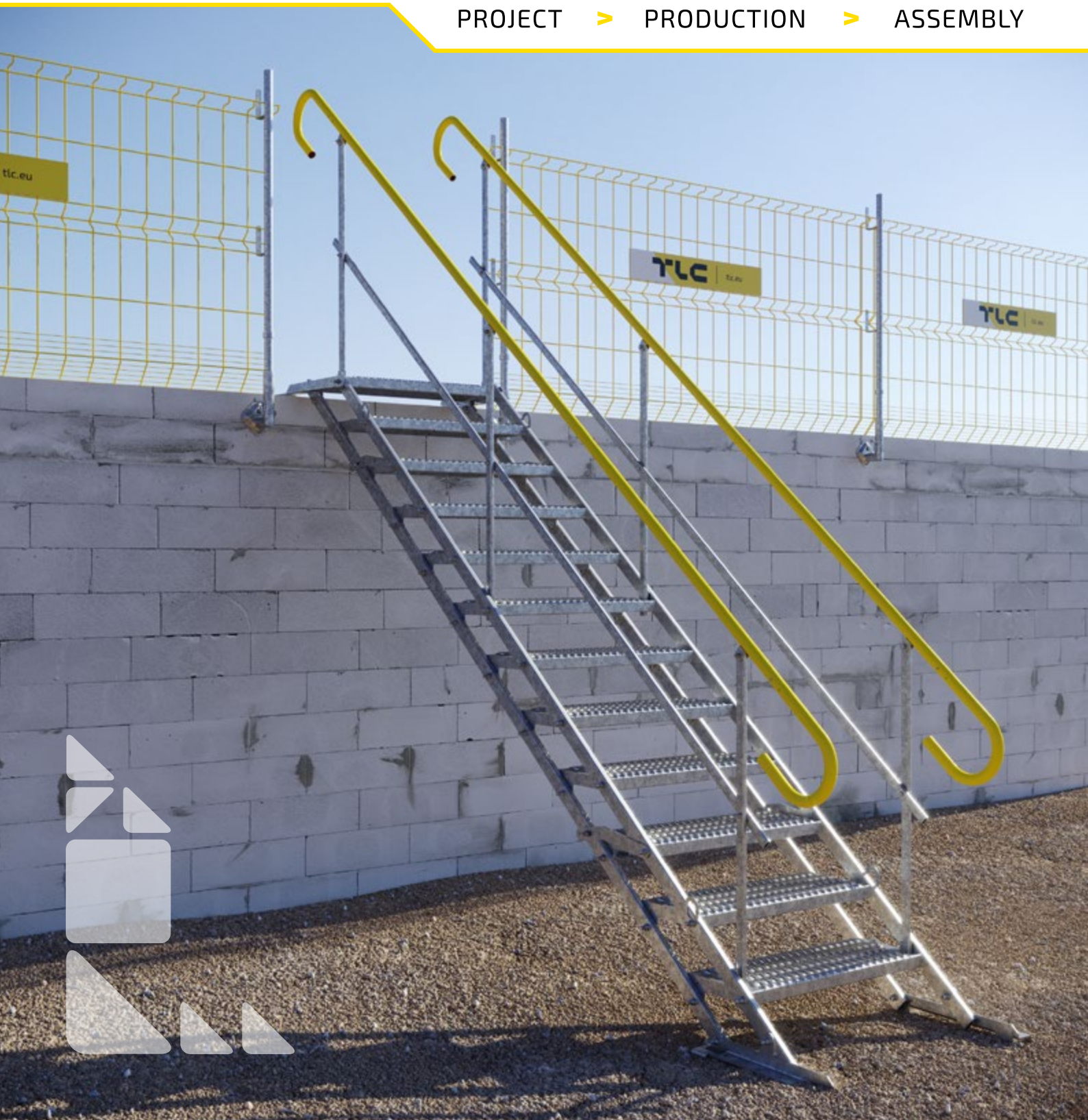

TAS - TEMPORARY ACCESS STAIRS AND STAIRCASES

PROJECT > PRODUCTION > ASSEMBLY





TLC



Swedish-Polish manufacturer with companies operating in Poland, Sweden, Germany and the UK



More than 15 years of experience in manufacturing stairs and steel platforms as well as construction safety systems



In-house engineering and technological offices as well as a research and development department



Modern and fully automated machinery park



Highly qualified engineering, technical and production staff



Comprehensive Customer service: design, manufacturing, sales, rental, transportation, assembly and repair services delivered all across Europe



Manufacturer, TLC Sp. z o.o., holds TÜV SÜD Polska certificate no. 2527 according to EN 1090-1 and PN-EN ISO 3834-2 certificate issued by TÜV SÜD Polska.

TLC's Production Plant has been certified with the Integrated Management System of Quality, Environment and OHS (ISO 9001/ ISO 14001/ ISO 45001) issued by TÜV SÜD Management Service GmbH.

The performance of construction products confirmed by CE mark.



The information in this advertising material is for reference only. The product specification should be subject to verification with technical data provided by the manufacturer.

INDEX

■ TLC GROUP	2
■ TAS SYSTEM - GENERAL INFORMATION	4, 5
■ TAS STAIRS - STEEL	6-13
• advantages of the system	
• length selection and stairs setup	
• additional components	
• scaffolding chucks	
• TAS step-over platform	
• gangway and truss	
■ STEEL TAS STAIRS - ACCESSORIES	14-17
■ TAS STAIRS - ALUMINUM	18-21
• advantages of the system	
• length selection and stairs setup	
• scaffolding chucks	
■ ALUMINUM TAS STAIRS - ACCESSORIES	22, 23
■ TAS STAIRCASES	24-27
• advantages of the system	
• module elements	
■ TRANSPORT AND STORAGE	28, 29
• transport and storage of TAS stairs and gangways	
• transport and sotrage of TAS staircases	
■ CHOSEN REALISATIONS	30, 31



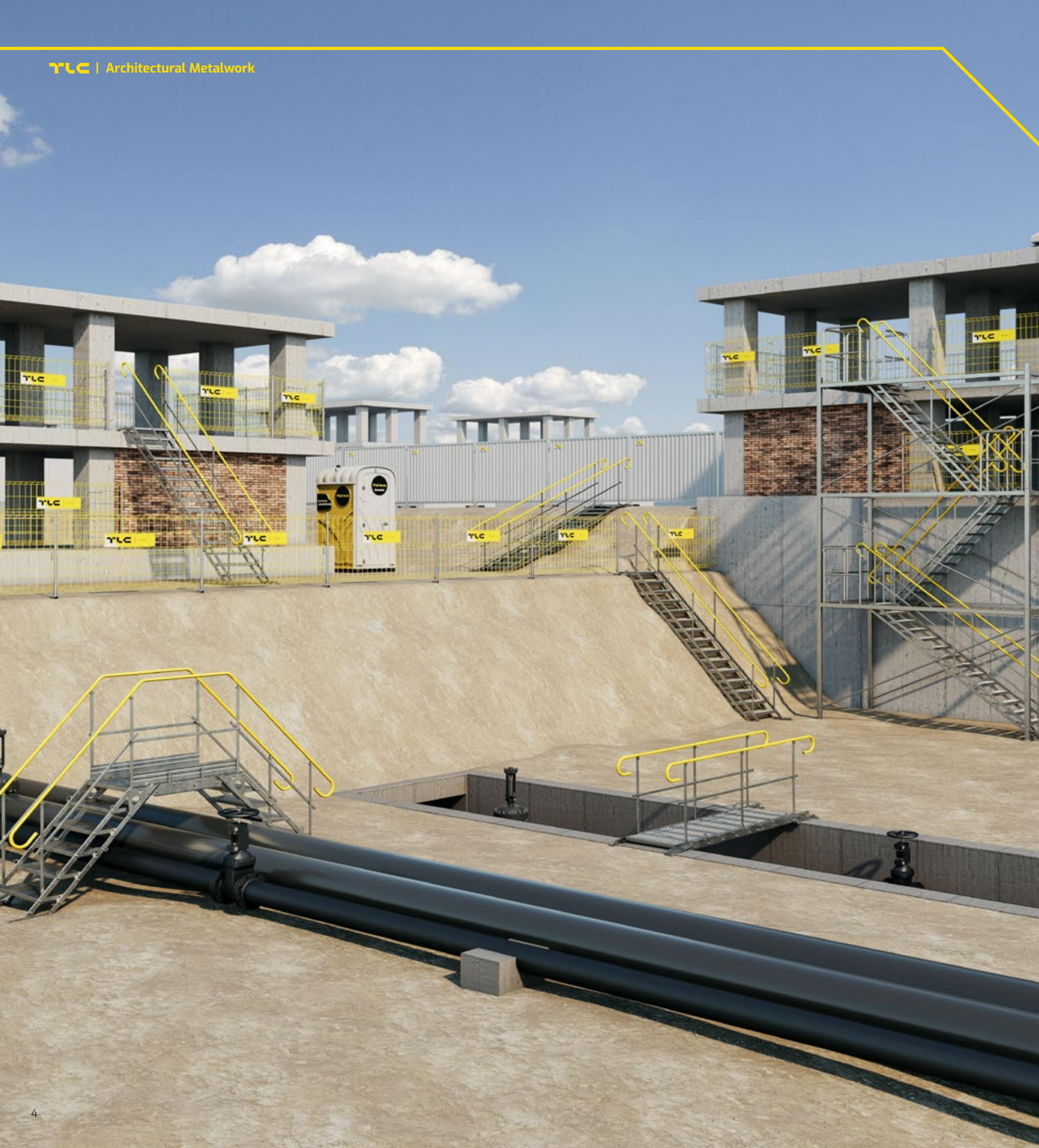

TAS SYSTEM

GENERAL INFORMATION

A safe solution that makes a great alternative to usually used, makeshift wooden structures. Modularity and universal purpose allows to use the system wherever there is a need of safe overcoming small and significant level differences.

Their main advantage is the possibility of safe, repeated assembly without losing its performance properties. The stairs are available in steel and aluminum version. Additionally, they have smooth angle regulation for better adjustment to required conditions. In order to increase visibility at the construction site, handrails are painted in yellow.

TAS SYSTEM APPLICATIONS:

- As temporary stairs to overcome small and significant level differences of various pitches (excavations banks, building tiers)
- As temporary gangways (excavations at road and construction works, trenches)
- As staircases to overcome significant level differences (buildings, deep foundation excavations e.g. underground parking lots)
- As a step-over platform to overcome small obstacles like walls or pipelines
- As scaffolding stairs - TAS stairs equipped with special chucks make it possible to assemble the stairs on scaffold systems.



STEEL

usable width 700 or 1000 mm
 temporary stairs
 gangways (up to 8 metres)
 scaffolding stairs
 step-over platform
 staircases



ALUMINUM

usable width 700 mm
 temporary stairs
 gangways (up to 2,8 m)
 scaffolding stairs
 step-over platform

KEY FEATURES OF THE SYSTEM

- Wide angle of inclination: from 0° to 50°
- Modularity - available in single flight modules with 3, 6, 9, 12, 15, 18 steps.

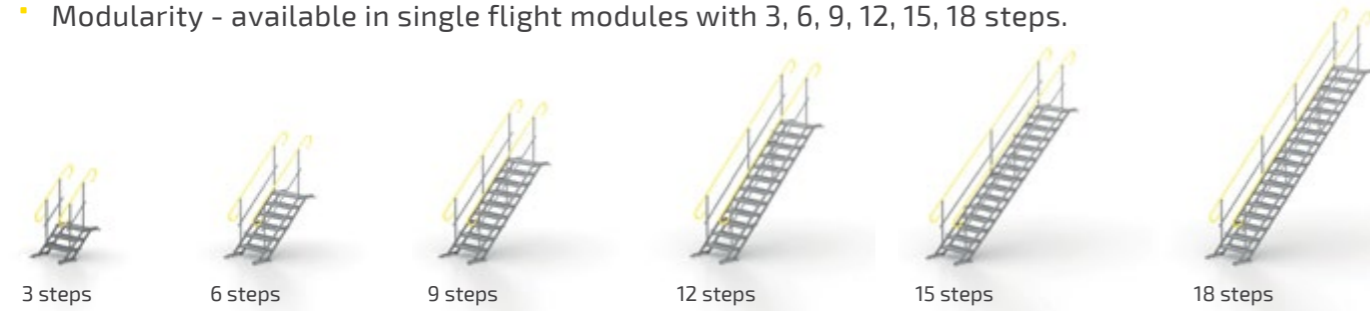

- Possibility to connect flights (e.g. 18+18, 15+12 steps) when using connectors and supports
- Possibility to mount railings on one or both sides
- Automatic steps levelling
- Possibility to change the place of use at any time
- Possibility to use a handle lowering last step



1,5 kN
↓
200 x 200 mm
▲
▲
Conformity with standard
PN-EN
12811-1:2007

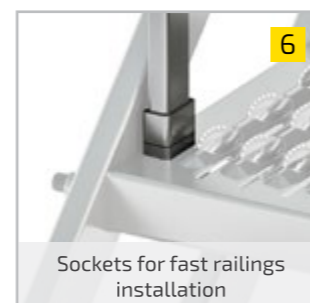
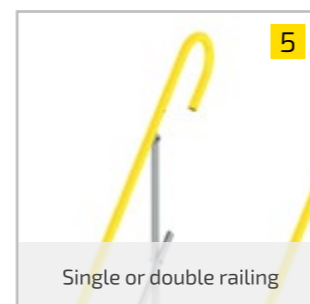
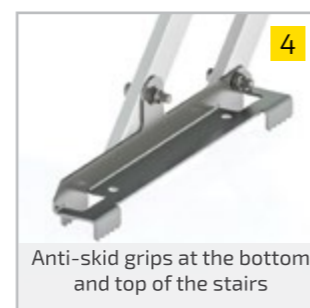
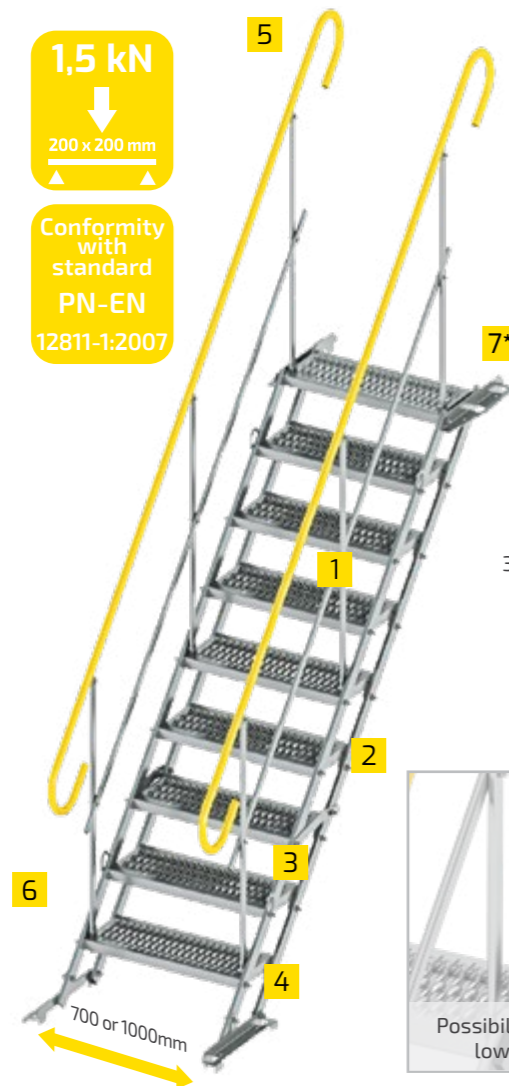
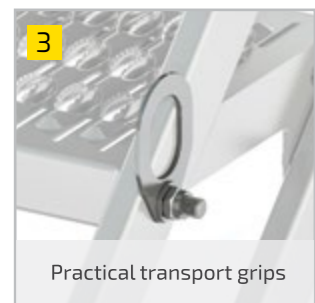
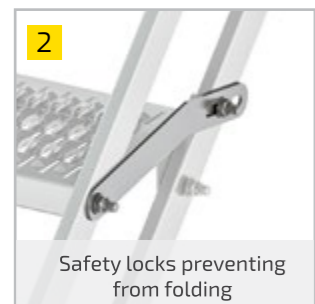

TAS STAIRS - STEEL

The stairs meet the requirements of the PN-EN 12811-1:2007 requirements regarding the class 1 carrying capacity (1,5 kN on 200x200mm surface) and are adapted for self-assembly with the use of a crane.

LENGTH SELECTION AND STAIRS SETUP

Temporary stairs system can consists of 6 basic modules of 3, 6, 9, 12, 15, 18 steps. Angle regulation is possible from 0° to 50° for modules from 3 to 12 steps, and from 25° do 50° for 15- and 18-steps modules. The stairs are to be assembled on a previousl prepared surface attaching the lower and the upper part. The table below shows basic parameters of the available modules.

NUMBER OF STEPS	3		6		9		12		15		18	
WIDTH [mm]	700	1000	700	1000	700	1000	700	1000	700	1000	700	1000
FLIGHT LENGHT [m]	0,8		1,61		2,42		3,23		4,05		4,86	
HEIGHT [m]	0-0,6		0-1,2		0-1,8		0-2,4		1,6-3,0		2,1-3,6	
WEIGHT [kg]*	47	56	74	93	105	134	133	171	162	208	192	248
POSSIBILITY TO USE AS A GANGWAY	YES						YES (when used with a truss)					

* weight includes stairs and two guardrails

Stairs location, i.e. their angle and distance between the lower upper end are determined on the diagram shown to the right as follows:

- Determine the excavation depth and mark the value on a vertical axis
- Taking into account the number o steps in the set, determine the angle of stairs - lead a horizontal line to the point of intersection with a curve.
- Determine the distance of the po-int of setting of the lower part of the stairs - vertical line to the intersec-tion with horizontal axis.

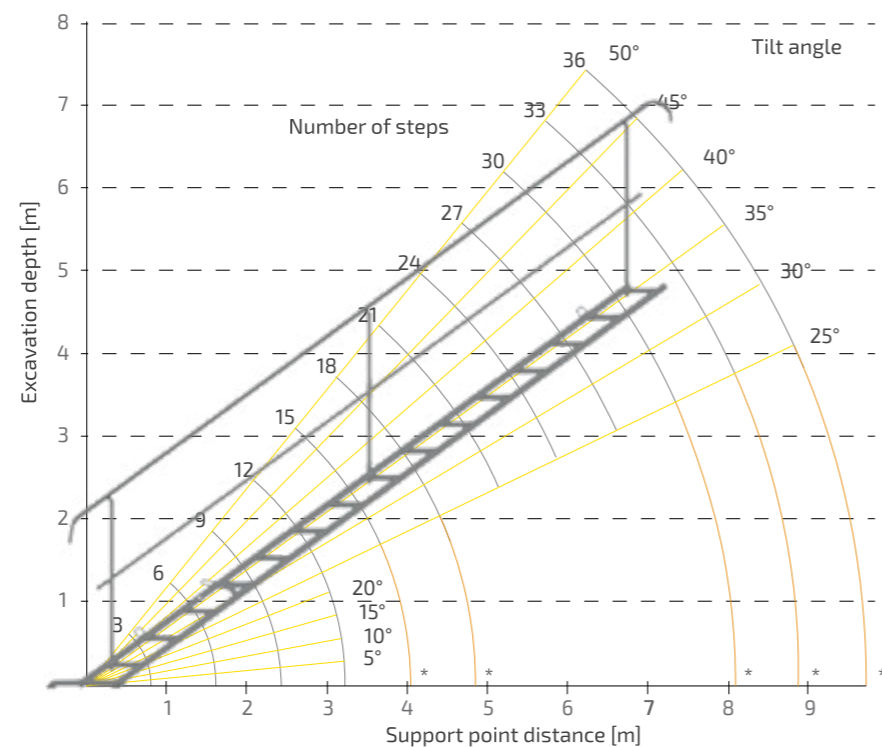

* gangway reinforced with a truss.

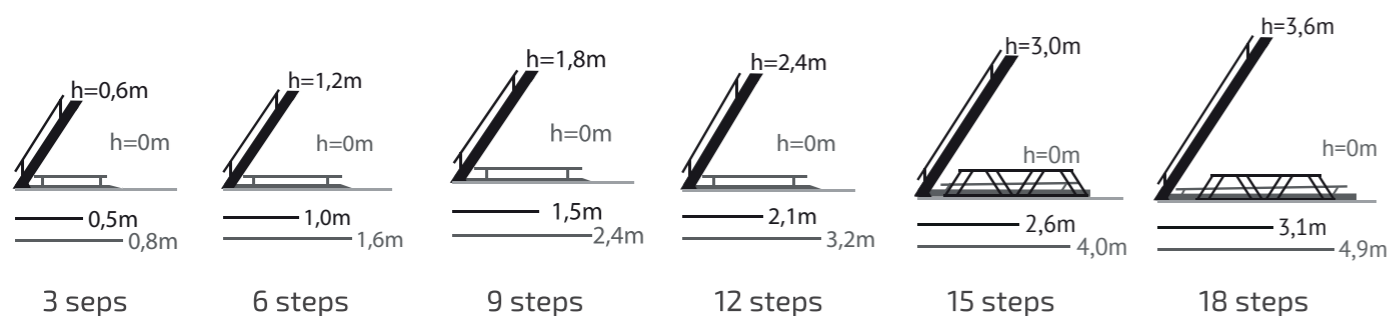

ADDITIONAL ELEMENTS

STAIRS FASTENERS

The structure of stairs allow to connect stair flights with each other using special fasteners.

SUPPORT POLES

When stair flights are connected, there is a need to use special support poles assembled to the stairs.

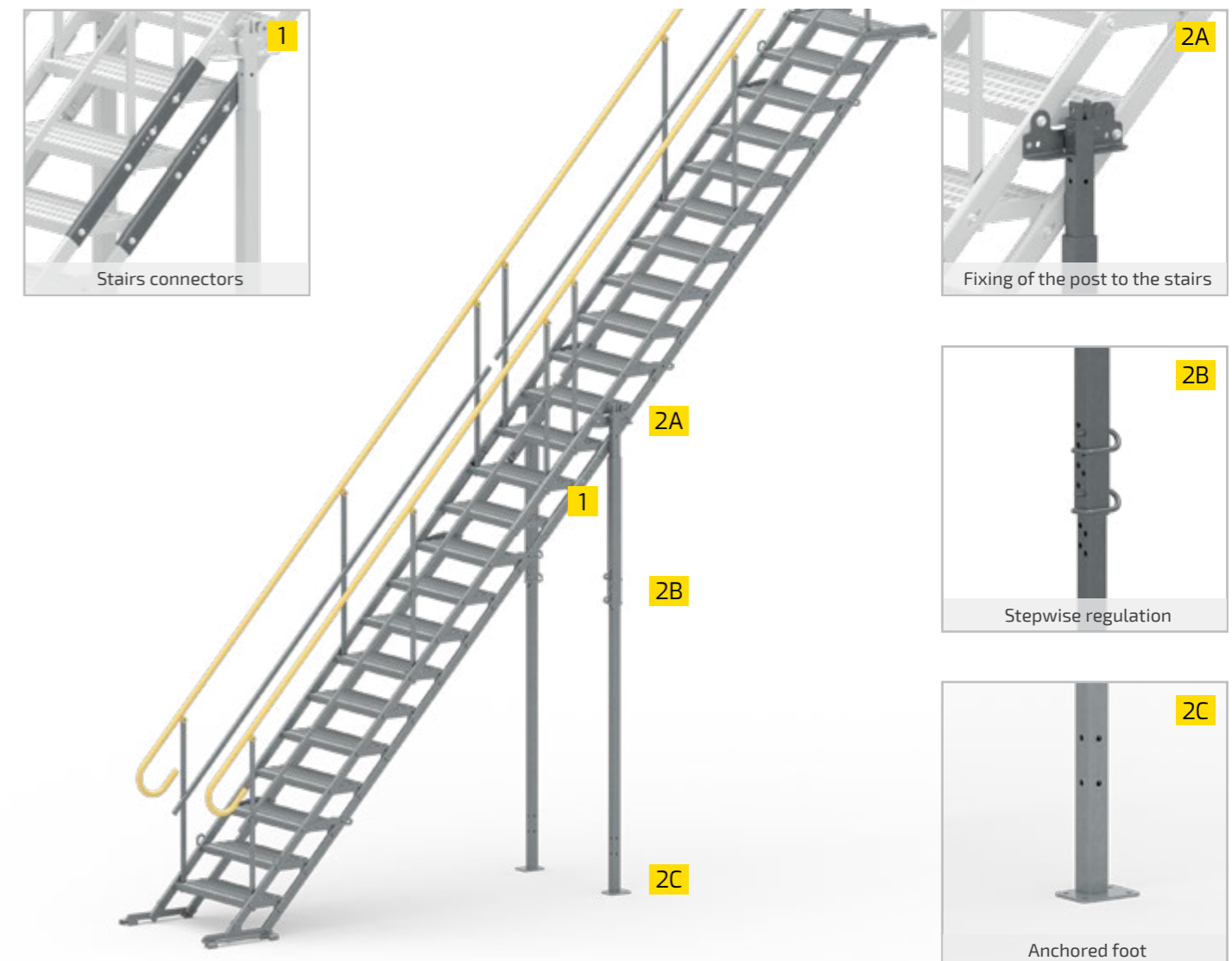

- When assembling and connecting flights on a bank, support poles are not required.
- Regardless of the flight angle, the steps are automatically set horizontally (parallel to the grips – upper and lower). If necessary, the adjustment can be made using the railings.

SCAFFOLDING CHUCK

- In order to optimise and adapt the product to the needs of the construction site, we have extended the TAS offer with scaffolding chucks. The assembly process is fast and troublefree, as it only requires exchanging standard feet with dedicated chucks.
- The assembly is conducted by hanging the upper stairs flight on horizontal traverse.



STEP-OVER PLATFORM

- TAS step-over platform is a modular and easy to assemble solution which consists of a platform and two TAS flights of stairs. The step-over stairs can be used to overcome such obstacles as pipelines, walls, or as a cross-over platform over excavations, trench boxes and small technical openings. Thanks to the possibility to use 3- or 6-step flights, the height of the platform can adjusted according to current needs.

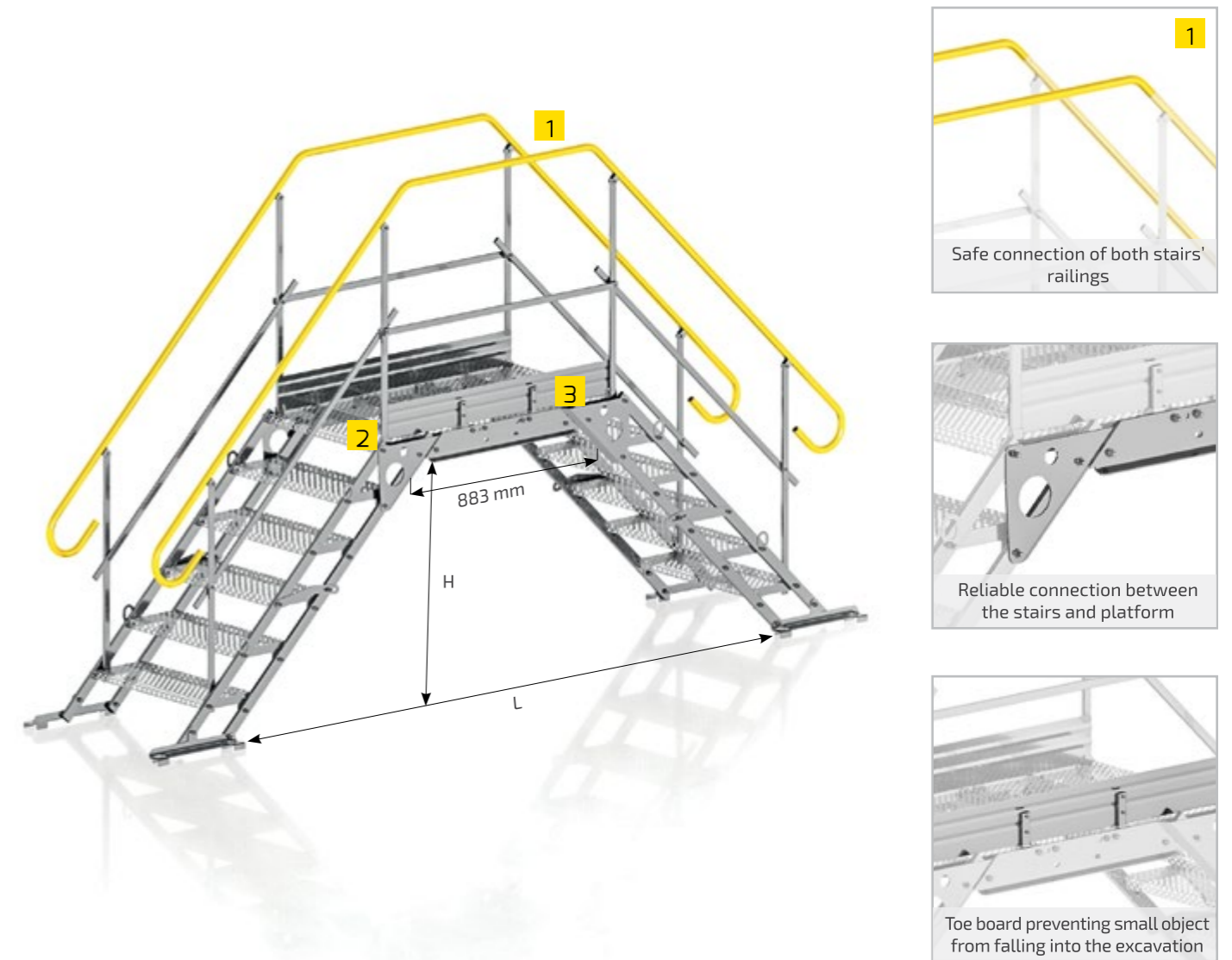

NUMBER OF STEPS	STAIRS WIDTH [mm]	WEIGHT [kg]	HEIGHT [m]	LENGTH [m]
3	700	93	0,46	1,8
	1000	107		
6	700	120	1,00	3,0
	1000	244		

GANGWAY AND TRUSS

In a basic version of TAS gangway, angle regulation from 0 to 50 degrees applies only for modules from 3 to 12 steps. When it comes to 15 and 18 steps long stairs, the basic regulation is from 25 to 50 degrees. In order to enable using the longest variants as gangways, we have extended the product offer with a **truss**.

All the possible TAS gangway connections with a truss are presented below.

1	TRUSS-15	15 steps gangway
2	TRUSS-18	18 steps gangway
3	TRUSS-2x15	Two 15 steps gangways
4	TRUSS-15+18	15- and 18 steps gangways
5	TRUSS-2x18	two 18 steps gangways

1 TRUSS-15

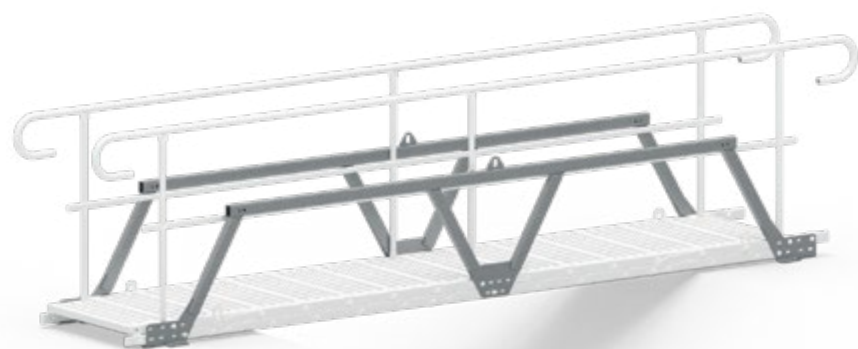

2 TRUSS-18

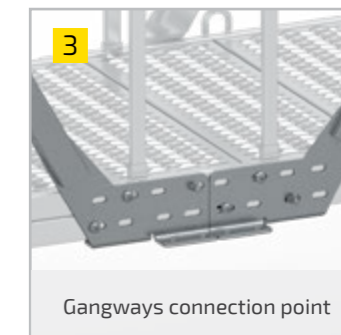
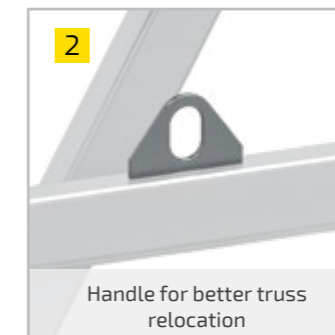
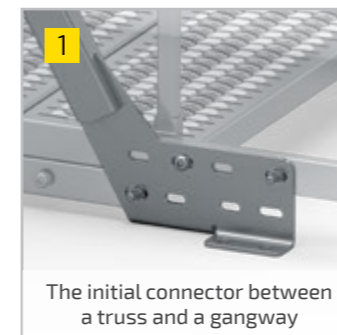
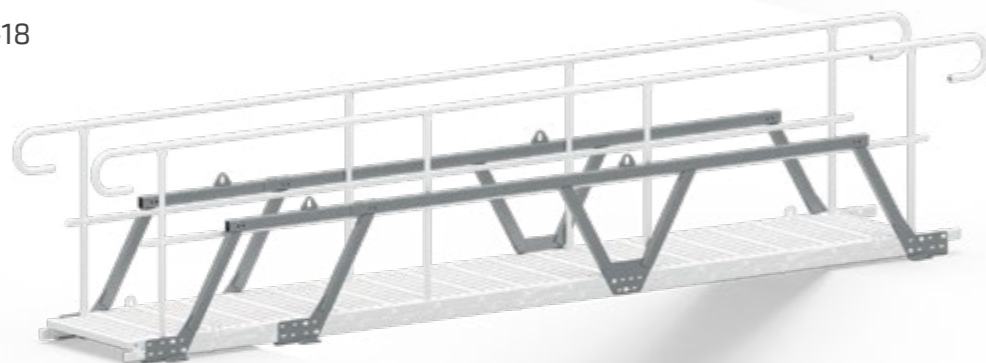

3 TRUSS-2x15

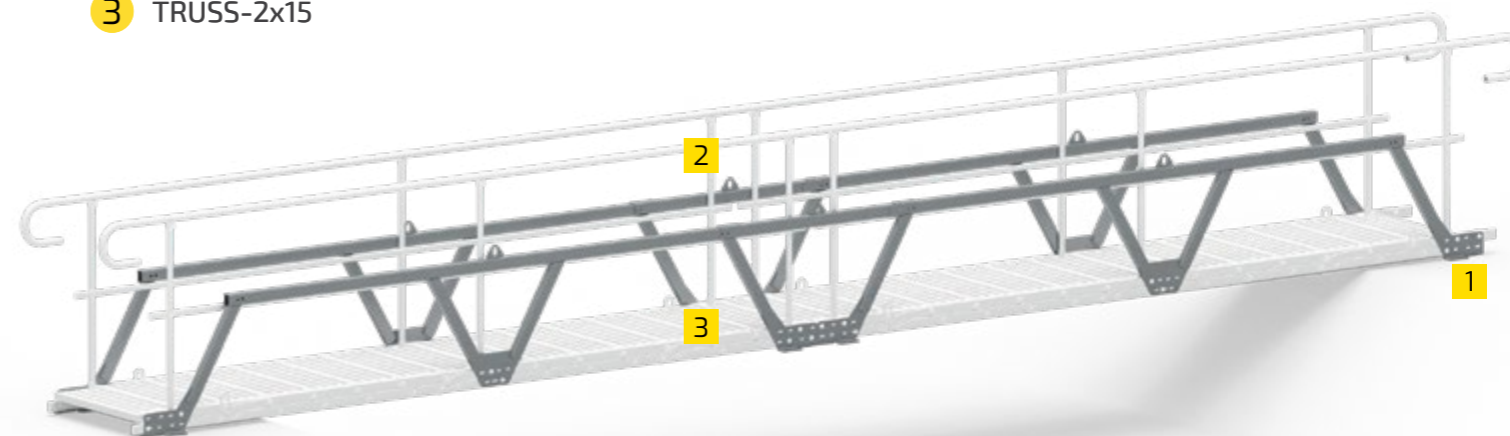

4 TRUSS-15+18

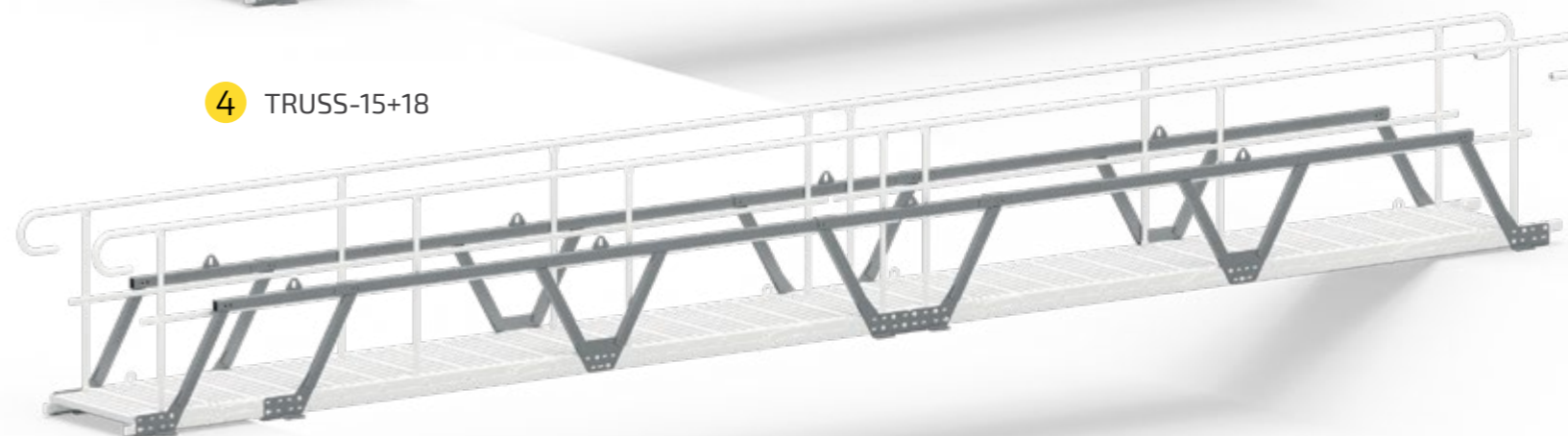

5 TRUSS-2x18

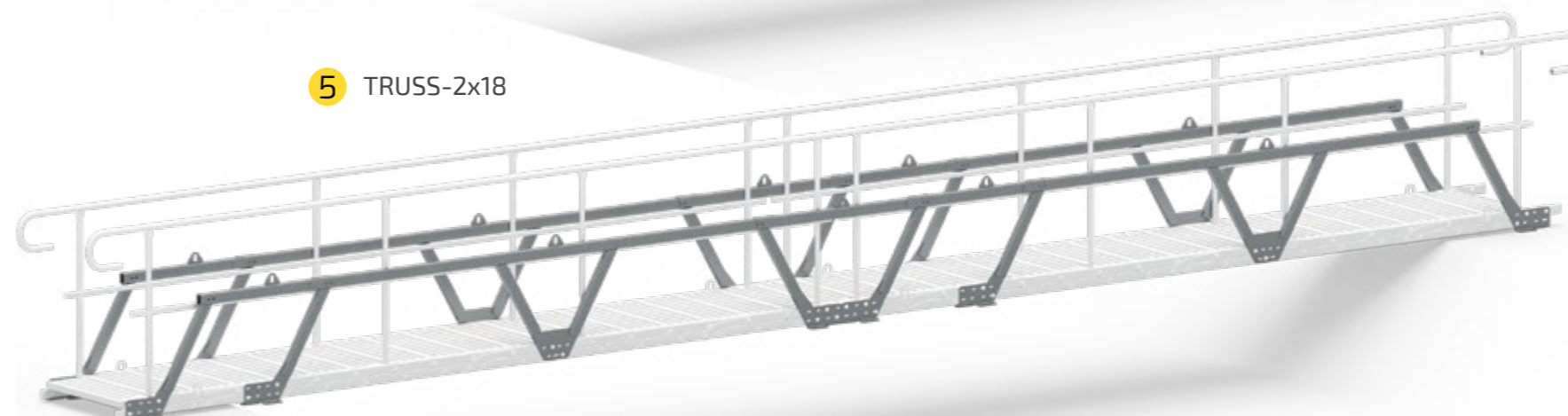

ACCESSORIES

Standard lower foot

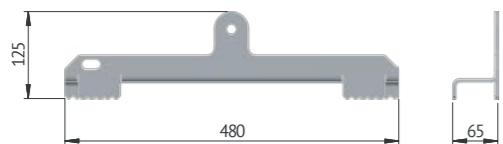

DESTINATION	WEIGHT	ARTICLE NO.
Assembly of the lower part of the stairs on stabilized ground.	1,8 kg	TAS-SDL2, TAS-SDP2

Lower flat foot

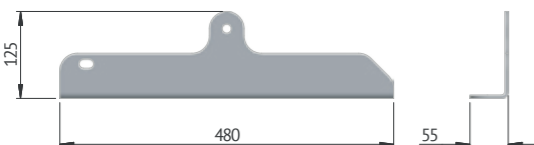

DESTINATION	WEIGHT	ARTICLE NO.
Assembly of the lower stairs flight on a surface that allows anchoring, e.g. concrete, wood, steel structures etc.	2,2 kg	TAS-SDLH, TAS-SDPH

Lower scaffolding chuck

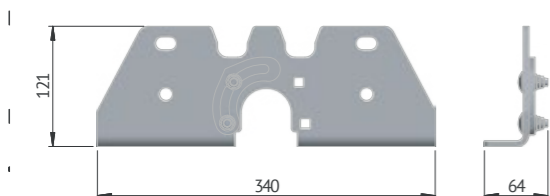

DESTINATION	WEIGHT	ARTICLE NO.
Assembly of the lower part of the stairs on a scaffolding.	2 kg	TAS-L16, TAS-L17

Upper standard foot

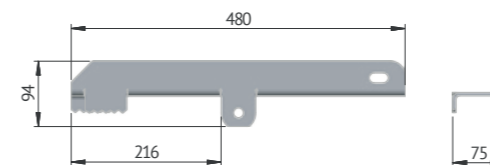

DESTINATION	WEIGHT	ARTICLE NO.
Assembly of the upper stairs part on stabilized ground.	2 kg	TAS-SGL2, TAS-SGP2

Upper foot levelling the final step

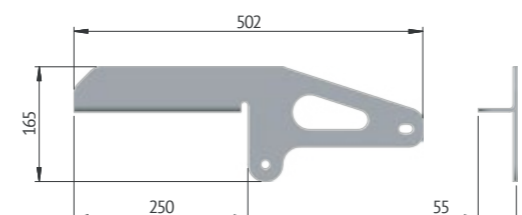

DESTINATION	WEIGHT	ARTICLE NO.
Assembly of the upper stair flight on a surface that allows anchoring, e.g. concrete, wood, steel structures, etc	1,9 kg	TAS-SGLH, TAS-SGPH

Upper scurrolding chuck

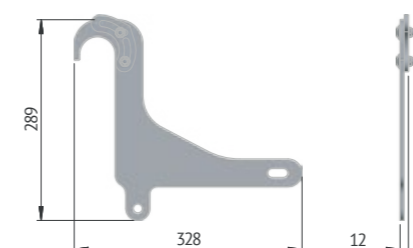

DESTINATION	WEIGHT	ARTICLE NO.
Assembly of the upper part of the stairs on a scaffolding.	1,3 kg	TAS-L14, TAS-L15

ACCESSORIES

- Upper foot that lowers final step.

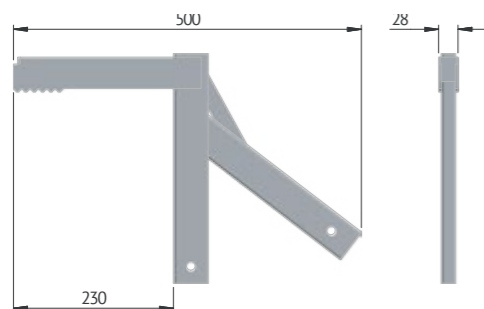

DESTINATION	WEIGHT	ARTICLE NO.
Upper foot that lowers final step.	2,1 kg	TAS-L26

- Stairs support / pole

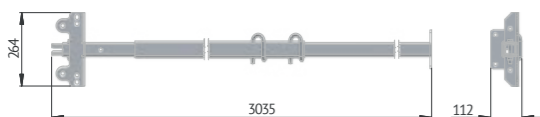

DESTINATION	WEIGHT	ARTICLE NO.
Stairs support	25,5 kg	TAS-PR5

- TAS-L12 for 70mm and TAS-L6 for 1000mm stair fasteners

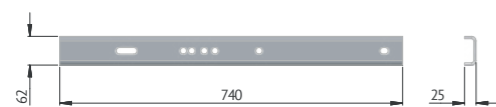

DESTINATION	WEIGHT	ARTICLE NO.
Stairs fastener L6 dedicated for 1000mm wide stairs, and L12 for 700mm wide stairs	TAS-L6 3,1 kg, TAS-L12 2,8 kg	TAS-L6, TAS-L12



KEY FEATURES OF THE SYSTEM

The product offer has been expanded with TAS stairs made of aluminum, which significantly reduces stairs weight while maintaining its functionality.

- Low weight - easy transport, assembly and disassembly
- Wide range of possible angles: 0 to 50 degrees
- Modularity - available in modules from 3 to 18 steps in a single flight



- Possibility to assemble railing on one or both sides
- Possibility to use a holder that lowers the last step (additional option)
- Automatic steps levelling

The stairs meet the requirements of the PN-EN 12811-1:2007 requirements regarding the class 1 carrying capacity (1 kN on 200x200mm surface) and are adapted for self-assembly with the use of a crane.



TAS STAIRS - ALUMINUM

LENGTH SELECTION AND STAIRS SETUP

Temporary aluminum stairs system can consists of 6 basic modules of 3, 6, 9, 12, 15, 18 steps. Angle regulation is possible from 0° to 50° for modules from 3 to 12 steps, and from 25° do 50° for 15- and 18-steps modules. The stairs, similar to their steel counterpart, are to be assembled on a previousl prepared surface attaching the lower and the upper part. The table below shows basic parameters of the available modules.

NUMBER OF STEPS	3	6	9	12	15	18
WIDTH [mm]	700					
FLIGHT LENGHT [m]	0,8	1,61	2,42	3,23	4,05	4,86
HEIGHT [m]	0-0,6	0-1,2	0-1,8	0-2,4	1,6-3,0	2,1-3,6
WEIGHT [kg]*	26,2	42	61	73	90	106
POSSIBILITY TO USE AS A GANGWAY	YES				NO	

* weight includes stairs and two guardrails

Stairs location, i.e. their angle and distance between the lower upper end are determined on the diagram shown to the right as follows:

- Determine the excavation depth and mark the value on a vertical axis
- Taking into account the number o steps in the set, determine the angle of stairs - lead a horizontal line to the point of intersection with a curve.
- Determine the distance of the point of setting of the lower part of the stairs - vertical line to the intersection with horizontal axis.

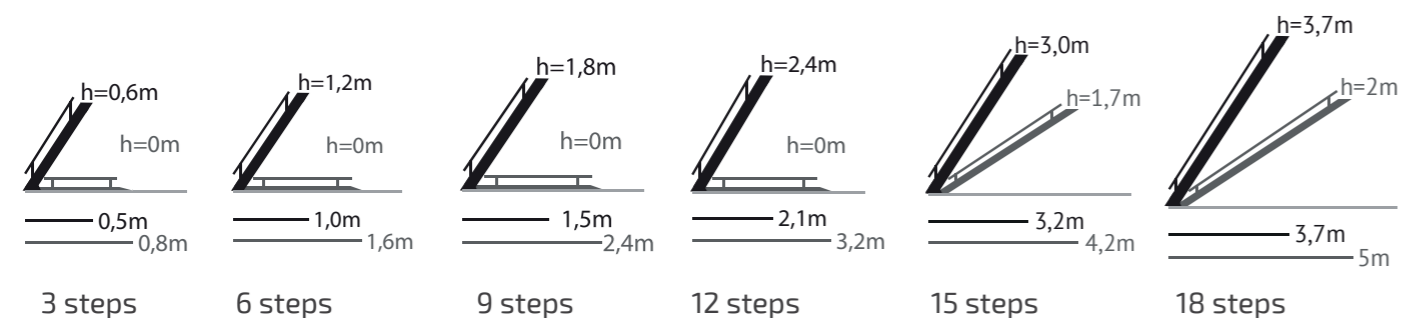
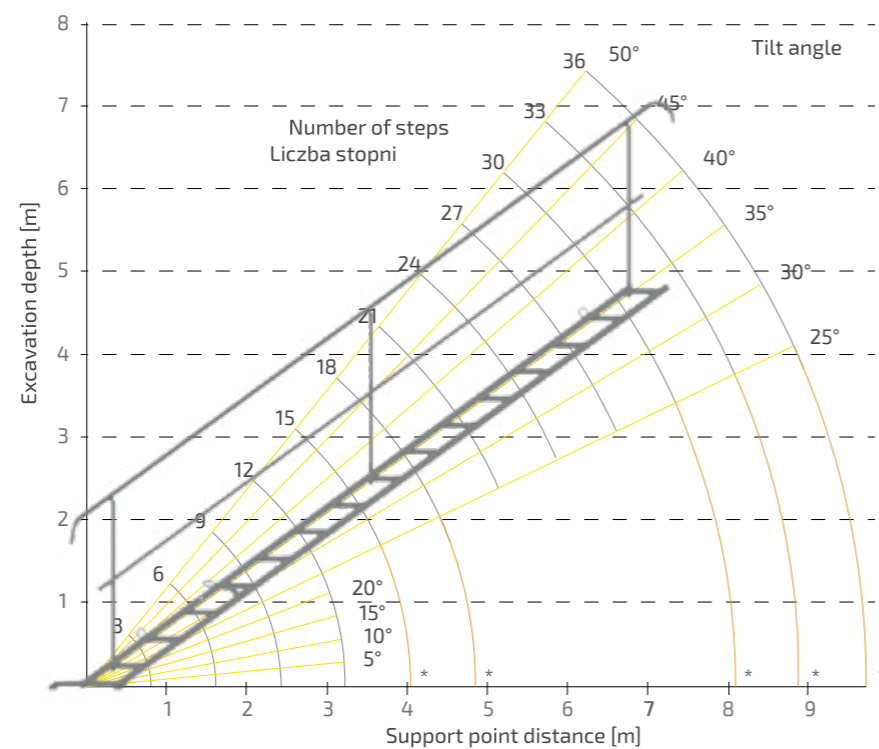

SCAFFOLDING CHUCK

In order to optimise and adapt the product to the needs of the construction site, we have extended the TAS offer with scaffolding chucks. The assembly process is fast and troublefree, as it only requires exchanging standard feet with dedicated chucks.

The assembly is conducted by hanging the upper stairs flight on horizontal traverse.



ACCESSORIES

Standard lower foot

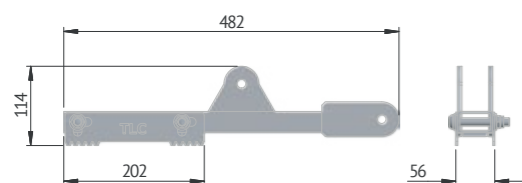

DESTINATION	WEIGHT	ARTICLE NO.
Assembly of the lower part of the stairs on stabilized ground.	1,45 kg	TAS-SDAL

Lower flat foot

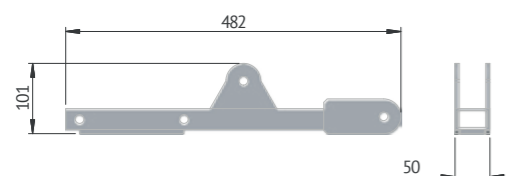

DESTINATION	WEIGHT	ARTICLE NO.
Assembly of the lower stairs flight on a surface that allows anchoring, e.g. concrete, wood, steel structures etc.	0,85 kg	TAS-SDAL1

Lower scaffolding chuck

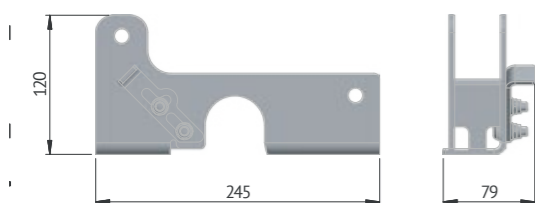

DESTINATION	WEIGHT	ARTICLE NO.
Assembly of the lower part of the stairs on a scaffolding.	0,7 kg	TAS-L21

Upper scurrolding chuck

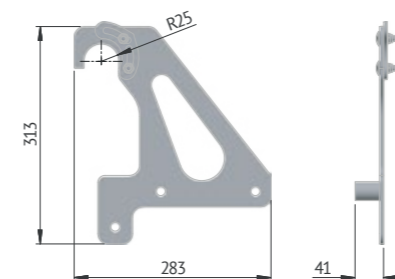

DESTINATION	WEIGHT	ARTICLE NO.
Assembly of the upper part of the stairs on a scaffolding.	1,7 kg	TAS-SGLH4, TAS-SGPH4

Upper standard foot

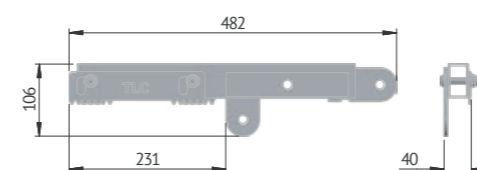

DESTINATION	WEIGHT	ARTICLE NO.
Assembly of the upper stairs part on stabilized ground.	1,2 kg	TAS-SGLAL, TAS-SGPAL

Upper foot levelling the final step

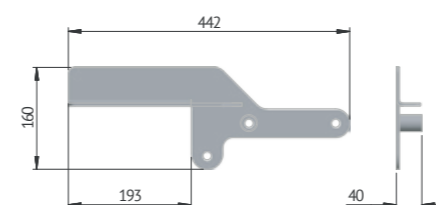

DESTINATION	WEIGHT	ARTICLE NO.
Assembly of the upper stair flight on a surface that allows anchoring, e.g. concrete, wood, steel structures, etc.	1,5 kg	TAS-SGLH3, TAS-SGPH3

Upper foot that lowers final step

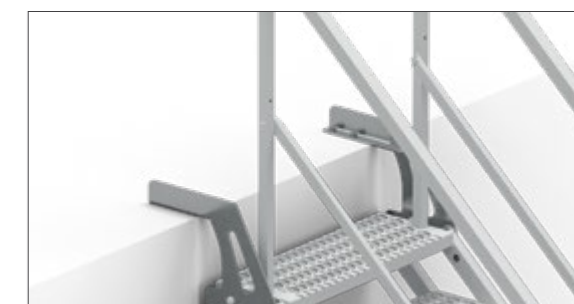
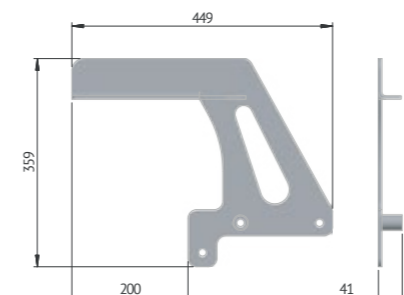

DESTINATION	WEIGHT	ARTICLE NO.
Assembly of the upper stair flight on a surface that allows anchoring, e.g. concrete, wood, steel structures, etc.	3,1 kg	TAS-SGLH5, TAS-SGPH5

KEY FEATURES OF THE SYSTEM

- TAS Staircases have modular construction which allows for a great number of available heights and directories of getting off the staircase. The system consists of two modules: BOTTOM and STANDARD, as well as TAS temporary stairs. The standard module always includes 12-step stairs, and the bottom one's number of steps depends on the module's height.
- Innovative solutions implemented in our staircases allow for safe communication even in the most demanding conditions.
- TAS staircase exit adapter was designed to eliminate level and distance differences between the staircase and the level you wish to get to. The staircase has a 7-step regulation (every 195mm). By using the adapter, you receive smooth regulation.

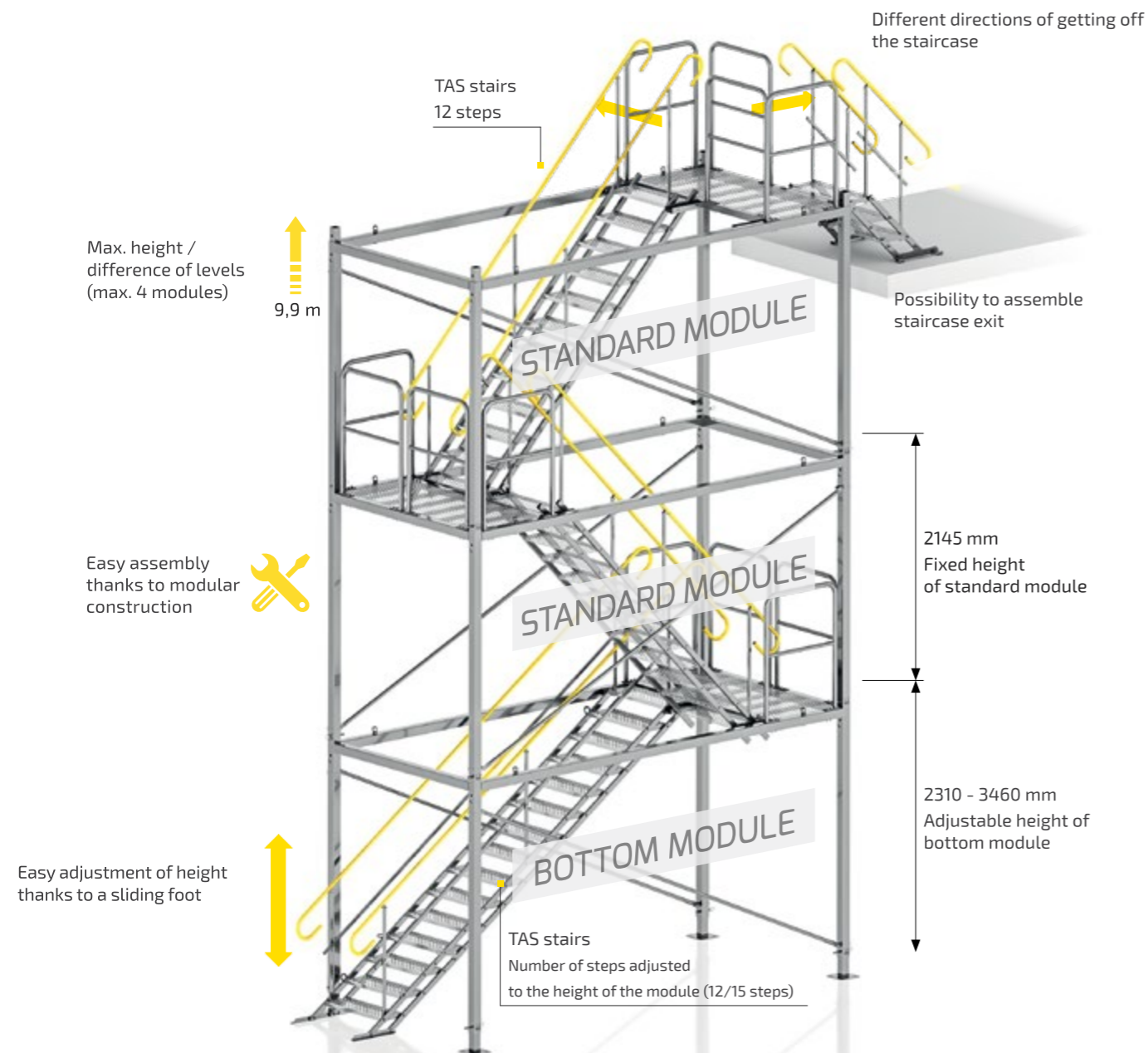

TAS STAIRCASES

MODULE ELEMENTS

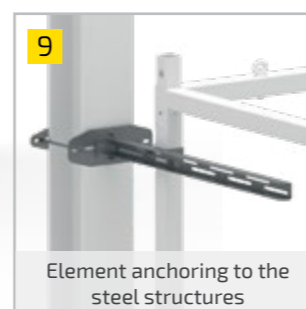
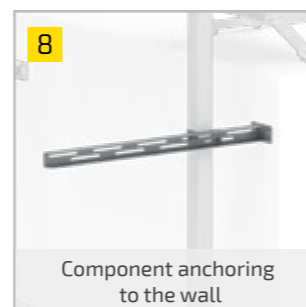
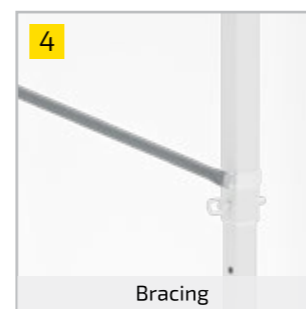
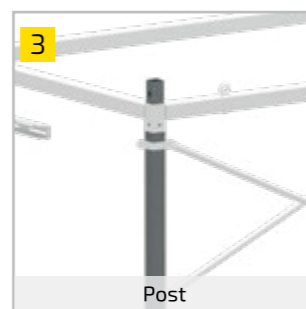
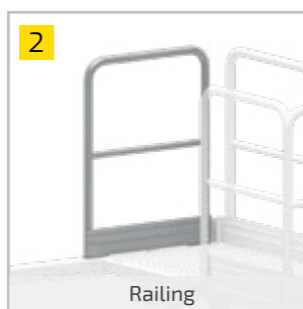

tlc.eu



The table below presents the list of main units for different types of modules.

NO.	DENOTATION	NAME	QUANTITY [pcs]		WEIGHT OF ELEMENT [KG]
			BOTTOM MODULE	STANDARD MODULE	
1	RA	Frame with platform	1	1	124
2	R-01	Railing	4	4	12
3	S-01	Post	4	4	21
4	X-01	Bracing	2	2	8
5	A-01	Foot	4	0	13
6	-	Kingpin	8	4	0.4
7	-	Clamping ring	4	4	0.15

TAS staircases manufactured by TLC comply with the requirements concerning load capacity in class 1 (1 kN of the surface of 200x200 mm). Staircases are adapted to self-assembly with the use of a crane.

TRANSPORT AND STORAGE OF TAS STAIRS / GANGWAYS

TAS stairs should be transported and stored with disassembled railings and folded to a minimum to reduce the space necessary for transport and storage. Use transport grips to lift the stairs. Stairs weight and dimension depend on a chosen variant.

Note: Applies to standard version. Does not apply to scaffolding chucks.

NUMBER OF STEPS	STAIRS WIDTH [mm] AND MATERIAL	3	6	9	12	15	18
WEIGHT [kg]*	STEEL 700	46,7	75,2	106,6	134	162,2	192,6
	STEEL 1000	57	93,8	134,6	171,2	209	248,5
	ALUMINUM 700	26	42	61	73	90	106
LENGTH WHEN FOLDED L [m]	L1	1,3	2,1	2,9	3,7	4,5	5,4
	L2	1,5	2,3	3,1	3,9	4,7	5,6

*weight includes stairs and two guardrails

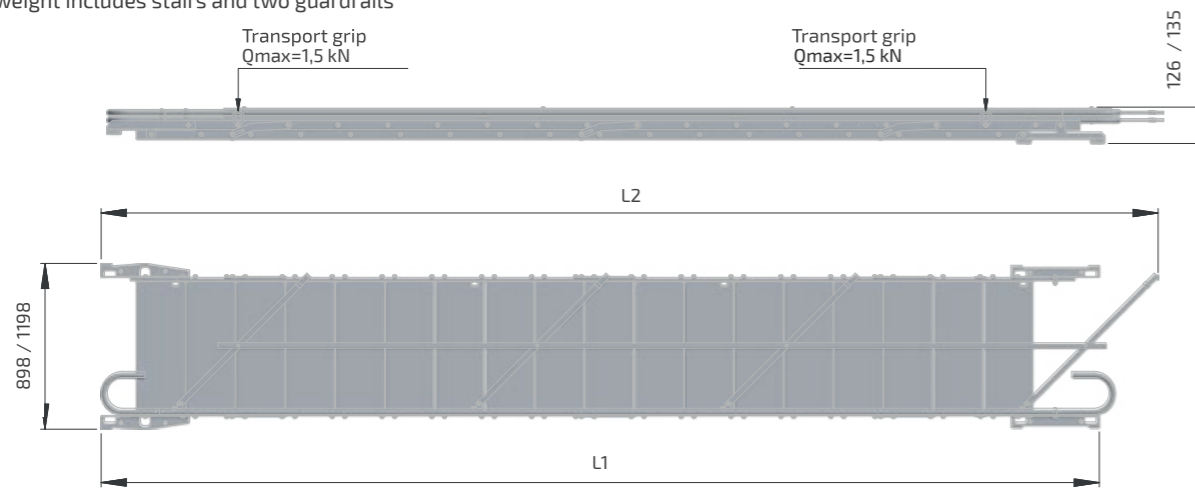

TAS stairs can be stored one on the top of the other. In order to secure the set from moving to the side, you can use transport grips - they should be set and locked with a mounting screw. See the picture below.

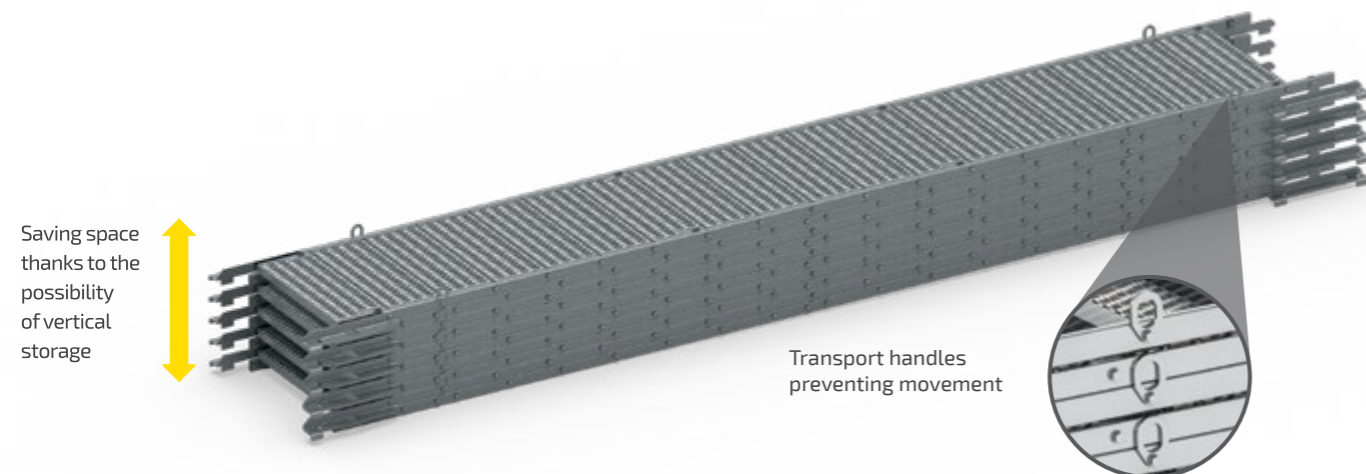

⚠ Maximum acceptable number of stored sets is 5

TRANSPORT AND STORAGE OF TAS STAIRCASES

TAS staircases should be transported and stored disassembled with individual elements arranged as in the figure below. It reduces the space required to transport and store the product. The weight of individual modules, without flights, are as follows: 326 kg (bottom module) and 275 kg (standard module).

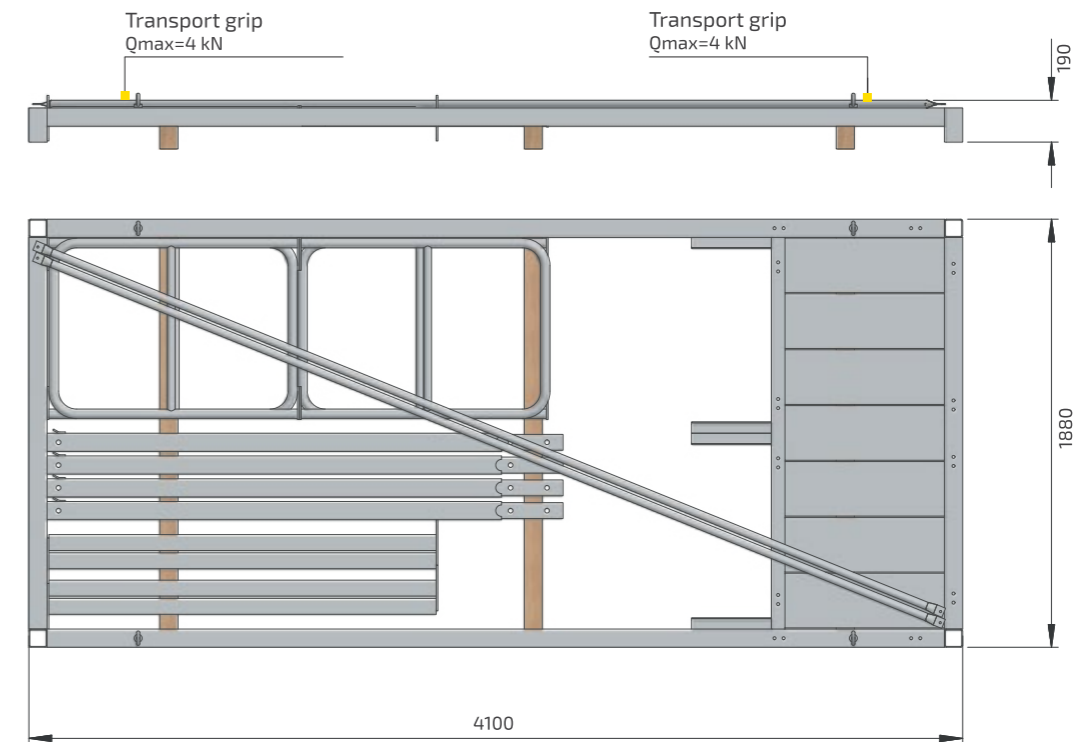

Disassembled TAS staircases can be stored one on the top of the other and transported together with TAS flights. In this case, the elements should be secured with wooden dividers (rectangle blocks). Individual elements should be fastened with transport belts.

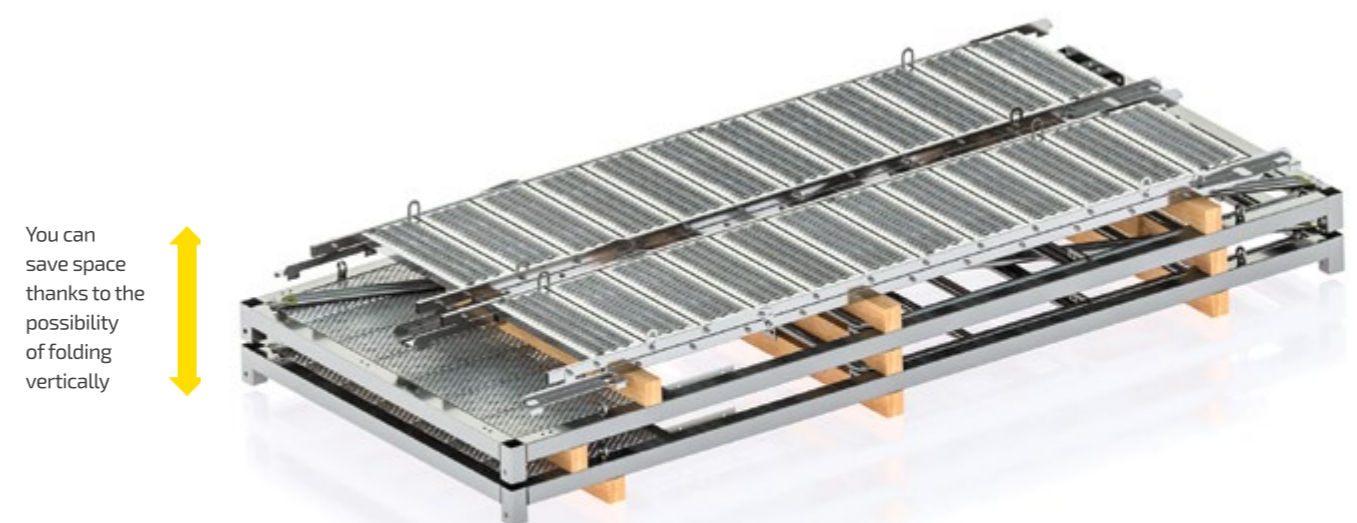

⚠ Maximum allowed number of stored modules is 3.

TEMPORARY ACCESS STAIRS AND STAIRCASES
CHOSEN REALISATIONS



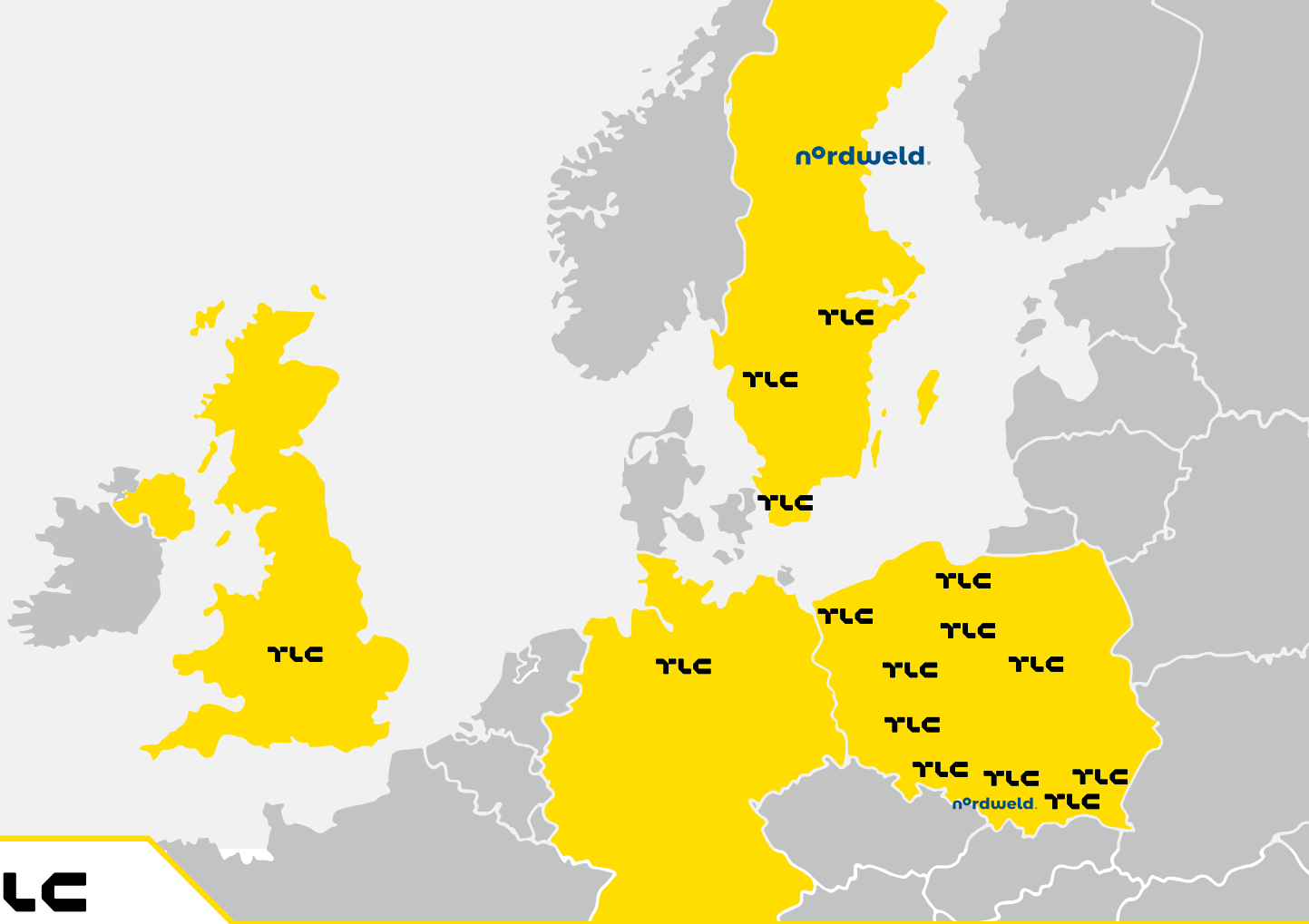

POLAND

TLC Sp z o. o.

+48 18 35 00 800
 info@tlc.eu
 tlc.eu

TLC Rental

+48 22 720 17 17
 info@tlcrental.pl
 tlcrental.pl

n°rdweld. Sp z o. o.

+48 600 151 551
 info@nordweld.eu
 nordweld.eu

SWEDEN

Inter **TLC** AB

+46 70 525 99 18
 info@intertlc.se
 intertlc.se

n°rdweld. TBS

+46 73 818 34 44
 info@nordweld.eu
 nordweld.eu

UNITED KINGDOM

Inter **TLC** Ltd

+44 2033 690 080
 info@intertlc.co.uk
 intertlc.co.uk

GERMANY

Inter **TLC** GmbH

+49 5147 709 00 72
 info@intertlc.de
 intertlc.de

TLC - MANUFACTURER OF STAIRS AND STEEL PLATFORMS FOR BUILDING INDUSTRY

TLC RENTAL - MOBILE PROTECTION SYSTEMS FOR CONSTRUCTION SITES

NORDWELD TBS - INNOVATIVE TANK BUILDING SYSTEM